



*All kind of solutions  
for your projects*



Our services: #-in-1 *ALL IN ONE !*

# Corporate Overview

## HEADQUARTERS SITUATED IN CATALONIA - SPAIN -

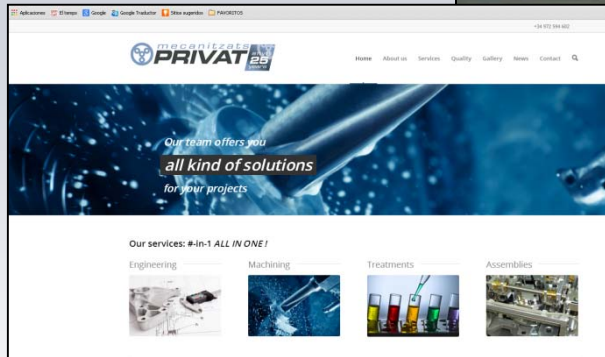

Our services: #-in-1 ALL IN ONE !

## Corporate Overview

***Mecanitzats PRIVAT is a full-service provider in the field of the CNC machining and precision assemblies.***

- ***Founded in 1988***
- ***Over 3M€ in anual revenues***
- ***Global operations***
- ***Diverse client base & sectors***
- ***Over 40 employees***
- ***[www.mecprivat.com](http://www.mecprivat.com)***

# Corporate Overview

## GLOBAL OPERATIONS

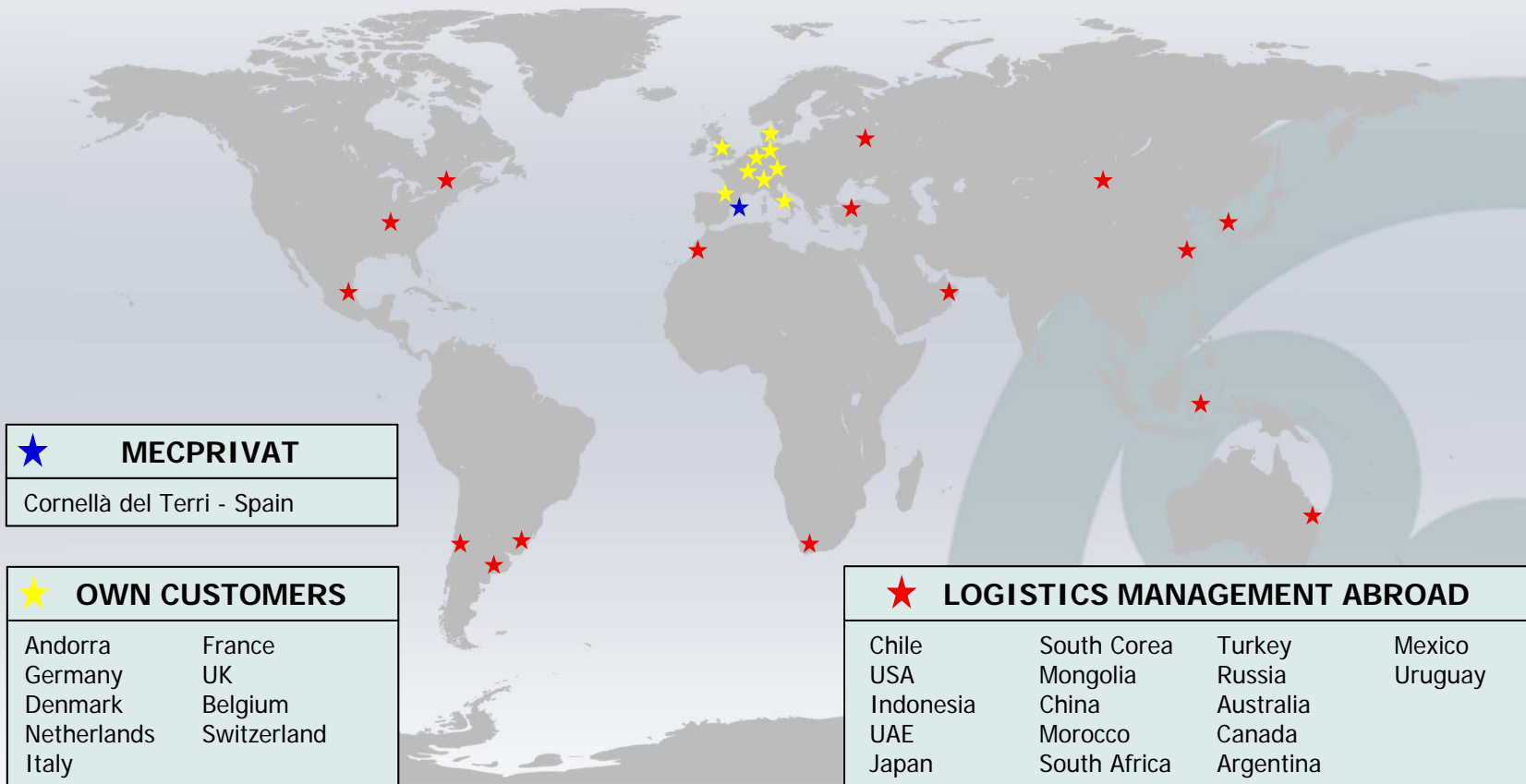

<b>★ MECPRIVAT</b>
Cornellà del Terri - Spain

<b>★ OWN CUSTOMERS</b>	
Andorra	France
Germany	UK
Denmark	Belgium
Netherlands	Switzerland
Italy	

<b>★ LOGISTICS MANAGEMENT ABROAD</b>			
Chile	South Korea	Turkey	Mexico
USA	Mongolia	Russia	Uruguay
Indonesia	China	Australia	
UAE	Morocco	Canada	
Japan	South Africa	Argentina	



Our services: #-in-1 *ALL IN ONE !*

# Corporate Overview

## RECOGNISED INDUSTRY LEADER

### BEST SUPPLIER OF THE YEAR 2012



#### ComexiGroup celebrates the 2nd edition of the Best Suppliers Awards

18 April 2013 / 0 Comments / in General / by metbach

Comexi Group, a specialist in solutions for the flexible package convertible industry, celebrated the 2nd edition of the Best Suppliers Awards. The company recognized the good work done by its main suppliers during the year 2012 and they also underlined the importance they have for the proper functioning of the company.

The event was held in the Parc Científic Tecnològic of the Universitat de Girona and it started with speeches of Comexi Groups managers and Michael Wershofen, vice president for Strategic Procurement Motion Control Systems at the German company Siemens. These speeches were related to business strategy, the role of the purchasing area in the changing global market and the supply chain.



**MECANITZATS PRIVAT S.L.**  
Com a millor proveïdor 2012  
En la categoria de  
Mecanitzats  
Març 2013

## Strategy

- ***Our vision is to provide our customers with the best technological solutions in mechanical devices field***
- ***Our mission is to supply solutions in a competitive way***
- ***Our values are collaboration, compromise and responsibility with our customers***
- ***Improving our business to business strategies***
- ***Continue implementing our Company Growth Plan***
- ***Compete in international strategic markets***

### **OUR MAIN GOAL**

*“Deliver a complete service to our customers, including full customization of the product”.*

## Strategy

### ***OUR KEY MARKETS***

- *Industrial machinery and devices*
- *Aerospace and defense industry*
- *Medical and pharmacy devices*
- *Optical and laboratory instrumentation*
- *Racing*
- *Robotics*
- *Energy*

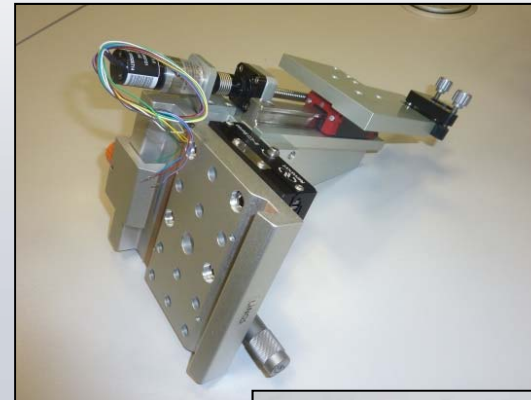

## SERVICES

### *WHAT WE OFFER*

- *ENGINEERING*
- *MACHINING*
- *TREATMENTS*
- *ASSEMBLIES*

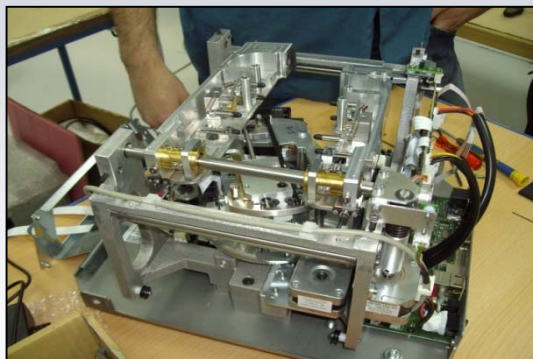



## SERVICES

### ***ENGINEERING***

➤ ***NEW PROJECTS***

*To make an idea as a new project*

➤ ***EXISTING PRODUCT***

*Mechanical, functional, assembling  
and maintenance improvements*

➤ ***MACHINING AND ASSEMBLING***

*IMPROVEMENTS*

➤ ***MACHINING PROCESS SOLUTIONS***

➤ ***CAD/CAM PROGRAMS***



#### **OUR SPECIALITIES**

- *Aeronautical tooling*
- *Optical*
- *Medical devices*
- *Robotics*

## SERVICES

### ***MACHINING***

*We have a full equipped workshop with turning, milling and finishing machines.*

*We offer to our customers:*

- *Prototyping*
- *Small series*
- *Medium series*
- *Large productions*



## SERVICES

### **TREATMENTS**

*We prepare our parts ready to assemble by the customer*



#### ➤ HEAT TREATMENTS

*Stabilizing*

*Induction*

*Tempering*

*Hardening*

*Normalizing*

*Nitriding*

*Carbonitriding*

*Cementation*

#### ➤ SURFACE TREATMENTS

*Degreasing*

*Polishing*

*Printing*

*Colour anodising*

*Surtec*

*Alodine*

*Bichromated*

*OAS (sulphuric anodising)*

*Chroming*

*Teflon nickel*

*Passivation*

*OAC (chromic anodising)*

*Hard chroming*

*Chemical nickel*

*Painting*

*OAD (hard anodising)*

*Sand Blasting*

*Electro-zinc coating*

## SERVICES

### **ASSEMBLIES**

*We also offer a complete assembly service to our customers when needed*

- *SCHEDULING*
- *PROTOTYPING*
- *MACHINING*
- *INSPECTION*
- *TESTING*
- *DELIVERY*
  - *Identification tags*
  - *Packaging*
  - *Special protections*

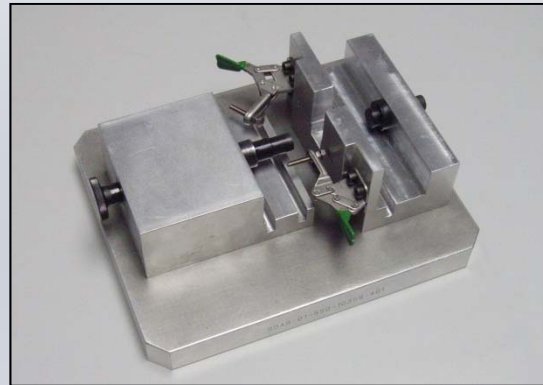

## TURNING machinery

- 2 x LATHE CNC 'MURATEC' mod. MW20G 2 spindles and gantry arm
- 2 x LATHE CNC 'CMZ' mod. TL-20M Rotary tools
- 2 x LATHE CNC 'CMZ' mod. TBI-480-A
- 1 x LATHE CNC 'CMZ' mod. TBI-520-A
- 1 x LATHE CNC-HANDLE 'HARRISON' mod. ALPHA 1550XS
- 1 x HANDLE LATHE 'TRENS-TOSS' mod. SN-500-S
- 1 x HANDLE LATHE 'TRENS-TOSS' mod. SN-630-S
- 1 x HANDLE LATHE 'PINACHO' mod. S-90/310
- 1 x HANDLE LATHE 'PINACHO' mod. L1-225

# TURNING machinery



## MILLING machinery

- 1 x MACHINING CENTER 'MATSUURA' mod. MX-520 -5 Axis
- 1 x MACHIINING CENTER 'OKUMA' Mod. MU 5000V 5Axis
- 2 x MACHINING CENTER 'OKUMA' mod. MX-45VAE + 4th Axe
- 1 x MACHINING CENTER 'OKUMA' mod. MB-56VA + 4th Axe +
- 1 x ABB Robot with Artifical Vision
- 1 x MACHINING CENTER 'DAEWOO' mod. Mynx 530 + 4th Axe
- 1 x MACHINING CENTER 'DAEWOO' mod. Mynx 550 + 4th Axe
- 4 x MACHINING CENTER FANUC ROBODRILL ALFA T21iEL + 4th Axes
- 2 x UNIVERSAL MILLING CNC 'METBA' mod. MB-50
- 1 x UNIVERSAL MILLING 'LAGUN' mod. FU-152 + digital readout
- 1 x MILLING 'METBA' mod. MB-1 + digital readout

# MILLING machinery





## FINISHING & ASSEMBLING

- 1 x TANGENCIAL GRINDER 'CHURCHIL' 500x300
- 1 x CNC BAND SAW 'DANOBAT' mod. CR-260 A.I with automatic charger
- 2 x VERTICAL DRILL 'ERLO' mod. TCA-40
- 2 x AUTOMATIC DRILL 'ERLO' mod. SER-25 with multispindle heads
- 2 x VERTICAL DRILL 'IBARMIA'
- 4 x PNEUMATIC TAPPER 'ROSCAMAT'
- 1 x HYDRAULIC TAPPER 'CMA'
- 1 x HOYTOM MACHINE
- 1 x MANUAL TOOLS FOR DEBBURING AND POLISHING
- 1 x CLEAN ROOM FOR ASSEMBLINGS

## QUALITY

*A great display of instrumentation and gauges allows us to inspect completely machined parts*

- *Three-Dimensional Machine CNC MITUTOYO Crysta-Apex 500*
- *Granite Surface Plate 800x600mm 'STARRET'- Grade 1*
- *Beanch Centers 0-600mm 'STARRET' – Accuracy 10 $\mu$ m*
- *Vertical column 0-600mm 'Brown&Sharpe' Accuracy 10 $\mu$ m*
- *Rectangular gauge block set 0-100mm 'Mitutoyo' - Grade 1*
- *Inside Micrometers 0-120mm 'Bowers' - Accuracy 5 $\mu$ m*
- *Inside Micrometers 0-50mm 'Mitutoyo' - Accuracy 1 $\mu$ m*
- *Outside Micrometers 0-300mm 'Mitutoyo' - Accuracy 10 $\mu$ m*
- *Digital Caliper 0-1.000mm - Accuracy 50 $\mu$ m*
- *Digital Caliper 0-1.000mm - Accuracy 10 $\mu$ m*
- *Digital and conventional calipers - Accuracy 1 $\mu$ m*
- *Thread gauges and bore gauges 6H*
- *Electronic bore gauges 'Marposs' Accuracy - 1 $\mu$ m*



## OTHER RESOURCES

*All our team is using the latest software technology available to ensure the excellence of our products. We succeed being faster, reliable and let us to achieve new challenges.*

- *Licences 'SAP SBO' Management ERP*
- *Licences 'SAP BE.AS' Production MERP*
- *Licences 'CATIA' Integrated CAD/CAM*
- *Licences 'PREDATOR' Comunication Management CNC*
- *Licences 'MCOSMOS' MITUTOYO Quality Software*

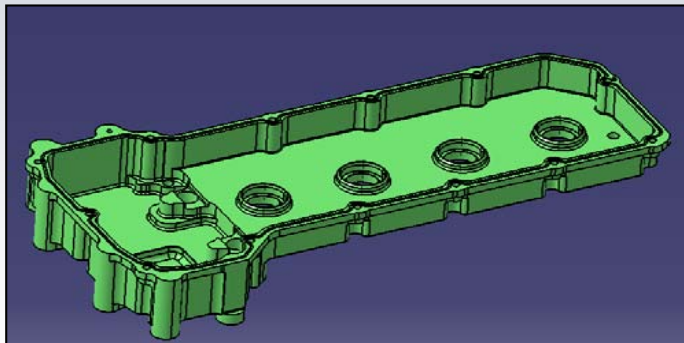
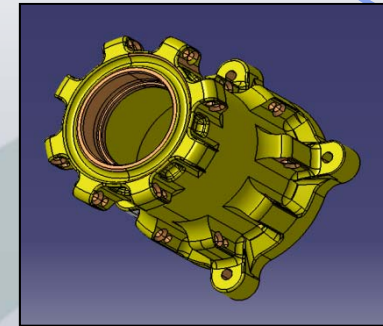

## SHORT SERIES examples

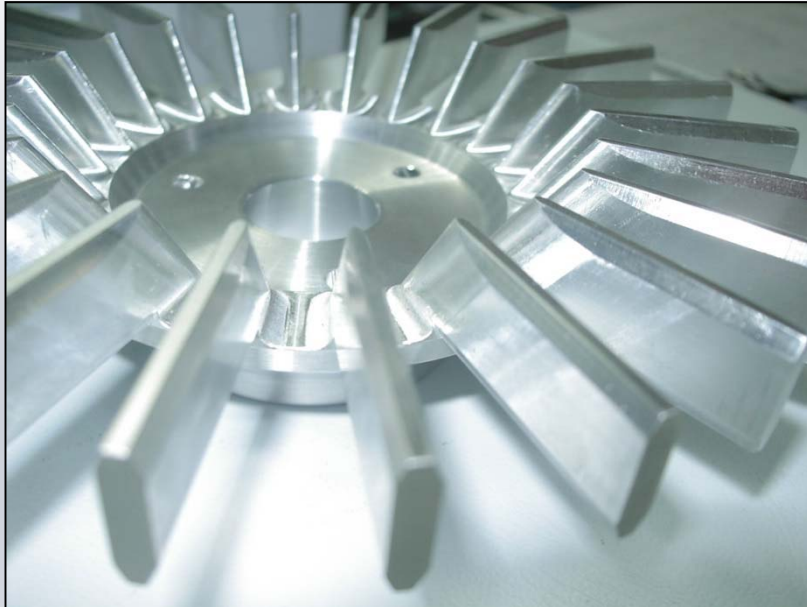

**Prototype Pump Impeller to special fluids**  
**Material: Aluminium 7075**

**Part for packaging machine**  
**Material: Aluminium 7075 Hard Anodized**

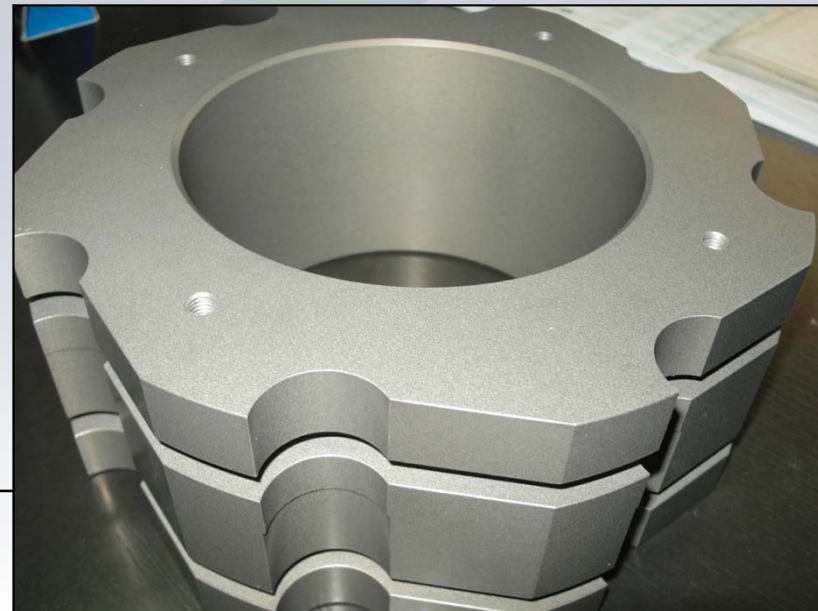

## SHORT SERIES examples



***Valve Body for pipeline***  
***Material: Superduplex***

***Rotor of special pump***  
***Material: Stainless Steel AISI-316***

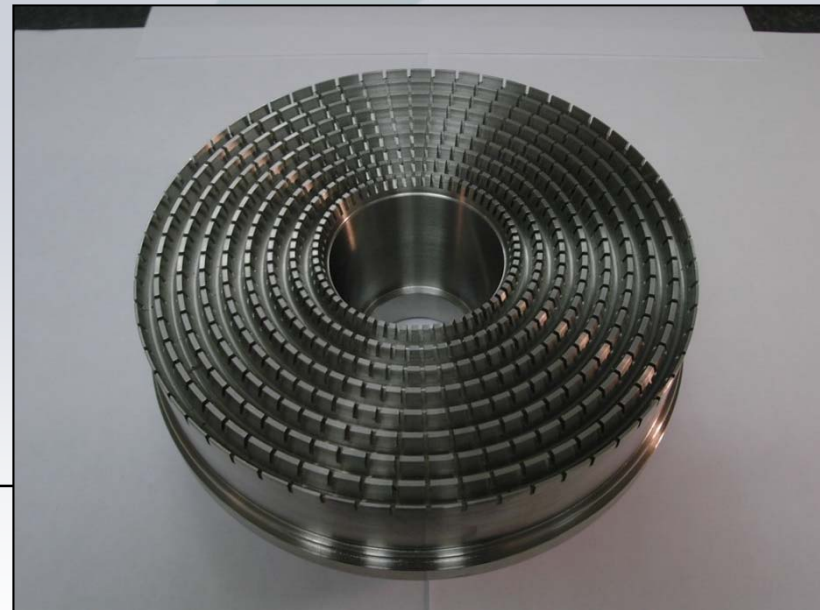

## SHORT SERIES examples

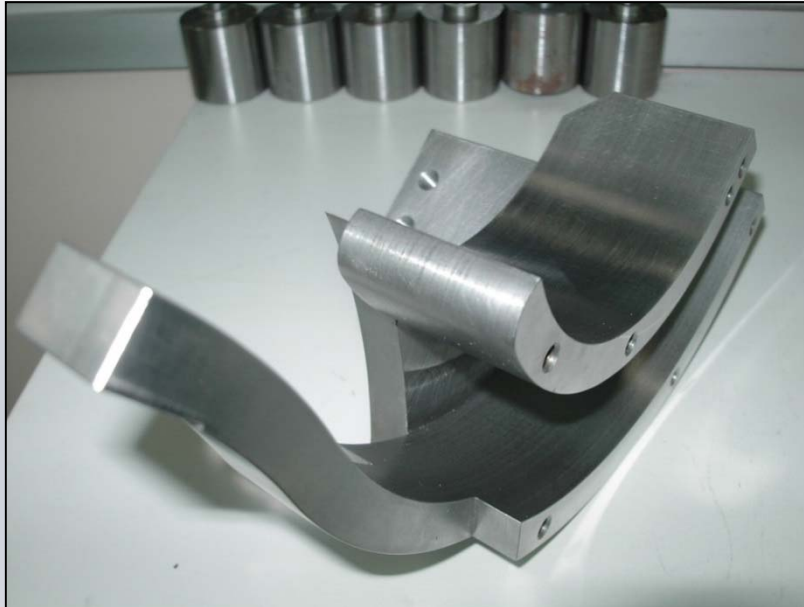

***Part for bottling industry***  
***Material: Carbon Steel ST-52***

***Admission part for Gas Turbine***  
***Material: Aluminium 7075***



## SHORT SERIES examples



***Mini Part for optical industry  
Material: Aluminium 7075***

***Mini Part for optical industry  
Material: Aluminium 7075***



## LARGES SERIES examples



***Body of water regulator***  
***Material: Brass***

***Impeller water pump***  
***Material: Cast Iron GG-25***





## LARGES SERIES examples



***Body of electrical motor***  
***Material: Aluminium***

***Body agitator***  
***Material: Stainless Steel foundry***



## ASSEMBLIES examples

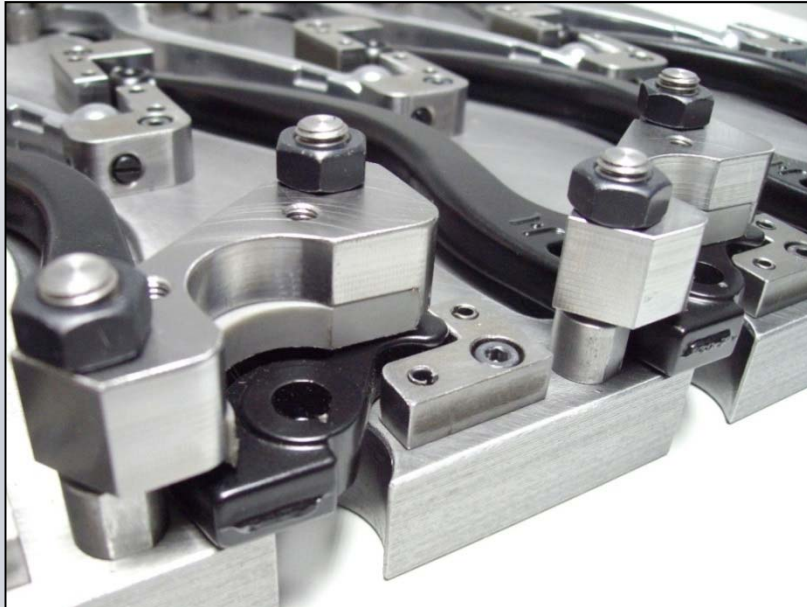

***Tooling for machining fixation***

***Automatic crane hook***



## ASSEMBLIES examples

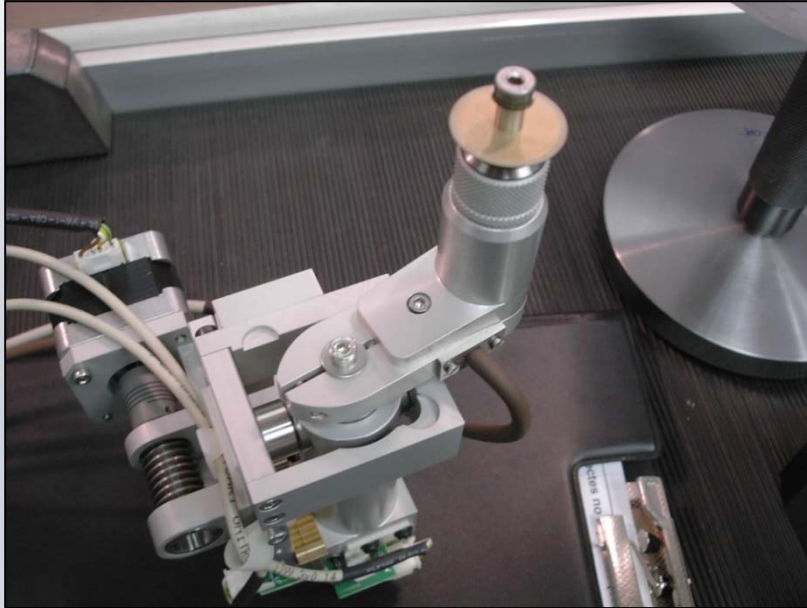

*Optical device*

*Optical device*

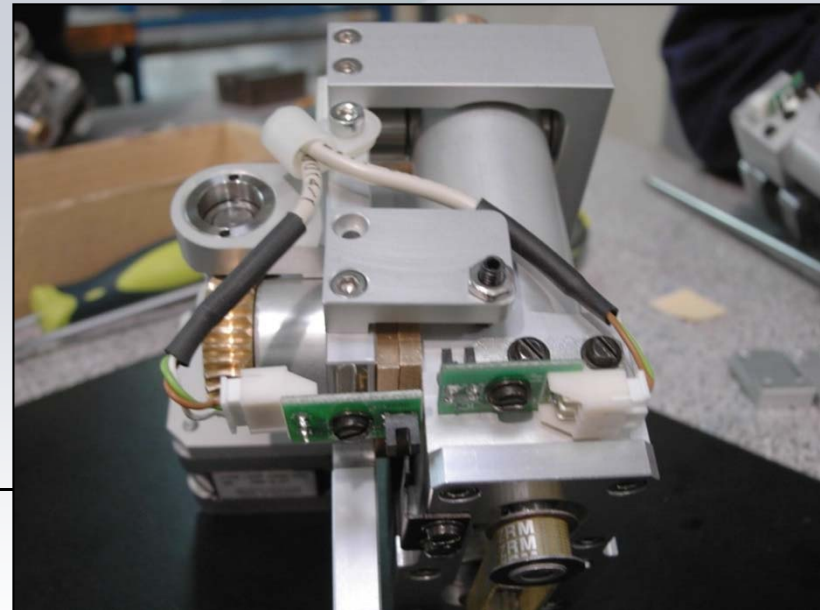

## ASSEMBLIES examples

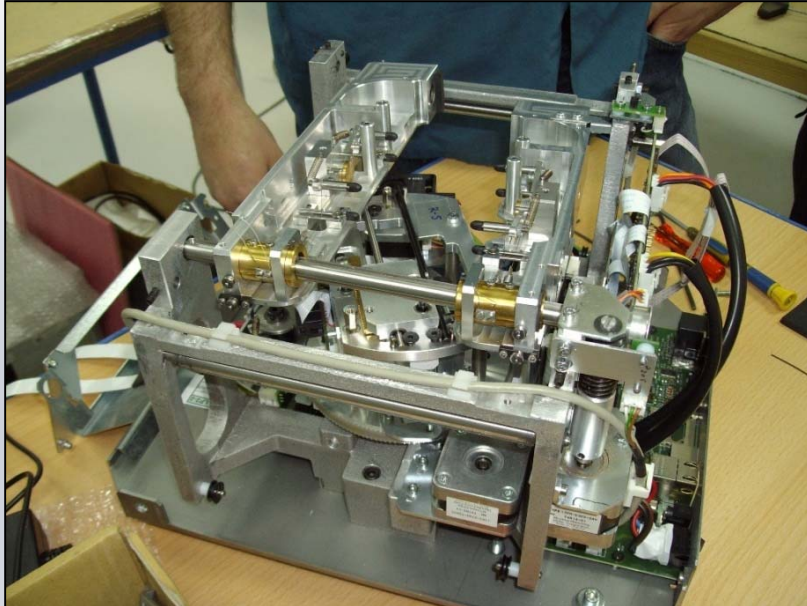

*Optical device*

*Optical device*

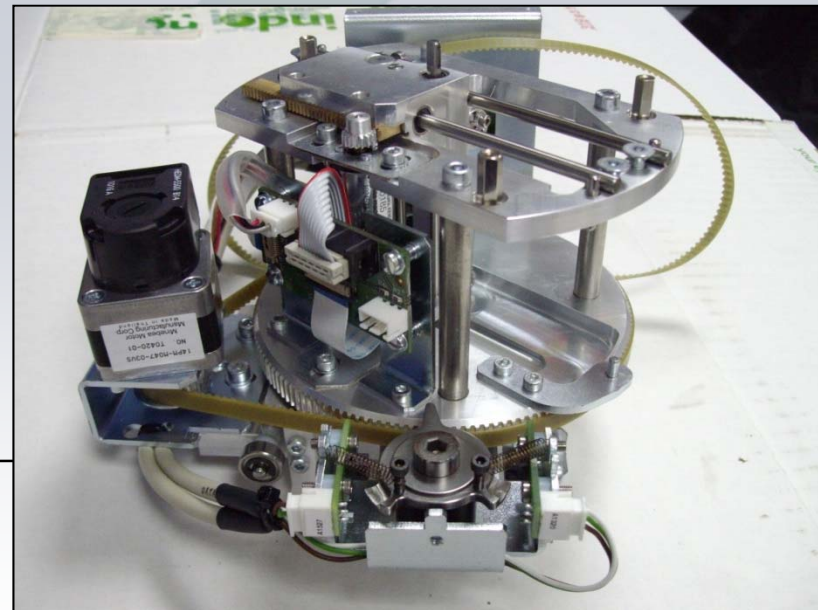

# ASSEMBLIES examples



**Laboratory instrumentation**

**Laboratory instrumentation**



# SITUATION

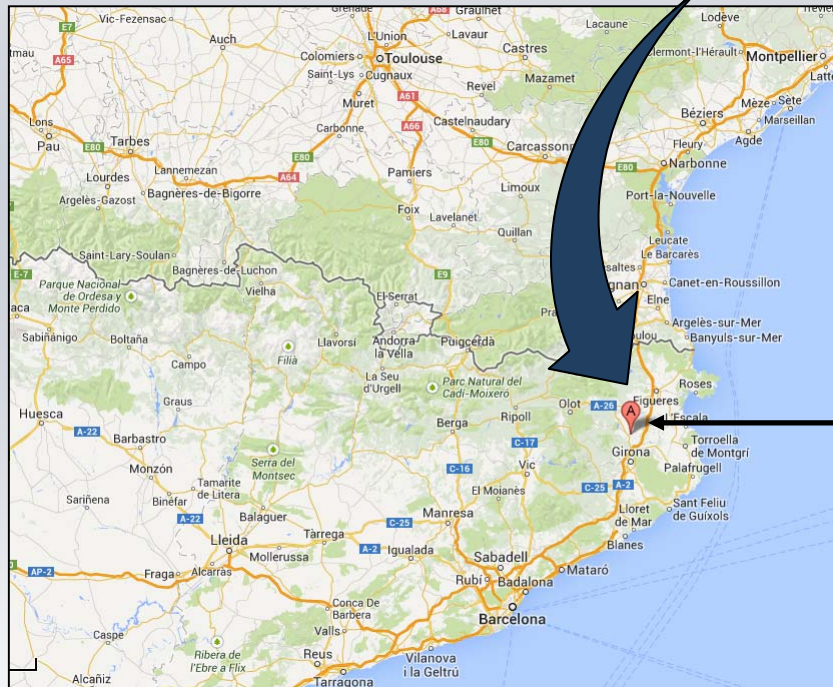

**MECANITZATS PRIVAT SL**  
**POL. IND. PONT-XETMAR C-10**  
**17844 CORNELLÀ DEL TERRI**  
**GIRONA - CATALONIA - SPAIN**



CNC machined parts  
& precision assemblies



Polígon Industrial Pont-Xetmar C-10  
E-17844 Cornellà del Terri (Girona)  
TEL +34 972 594 602 · FAX +34 972 594 832  
[www.mecprivat.com](http://www.mecprivat.com) · [info@mecprivat.com](mailto:info@mecprivat.com)



Our services: #-in-1 *ALL IN ONE!*