



Material Behavior In Micro Molding

Comparison of Thermoplastic Material, Microscopic Size, Tight Tolerance and Thin Wall Characteristics

Injection molding microscopic thermoplastic components while observing micron tolerances and high precision geometries is what we have perfected and continue to improve for over three decades.

Background

Accumold is a world leader in high-volume precision micro molding and has expertise in micro electronics, medical technology, wearables, emerging technologies, automotive and fiber / micro optics.

The company began operations in a rented garage when the founders discovered there was a growing need to manufacture small and micro injection molded components that went well-beyond the available molding systems of the day. This discovery led to the invention of our first Micro-Mold® platform in 1985.

Since those early days, our focus has remained steadfast to the art and science of micro injection molding. In fact, Accumold is the only company that has been continuously dedicated to micro molding for over 30 years. We remain committed to serving high-tech industries that require high-volume, small, complex micro injection molded parts with high quality and fast turn-around.

There is probably little doubt that just about everything we come in contact with today has some form of plastic as part of its design. Plastic has played an interesting role in our history if you think about some of the transformations in the recent past. Many of us have watched everyday items slowly evolve from other materials such as wood, metal, leather and even cotton. Some might say it's revolutionized the way we work, live and play. Some of the changes we might argue are less-than-desirable, but nonetheless, plastics have become an essential part of today's world.

Material History

A man by the name of Charles Goodyear is credited with discovering natural rubber in 1839. The first man-made plastic, celluloid, is said to have been invented by Alexander Parkes in 1862. Other milestones include Polystyrene (PS), developed in 1839 (but not used in a practical application until 1938 almost a hundred years later). Nylons began on the scene in 1939, Polypropylene (PP) in 1941 and Liquid Crystal Polymer (LCP) not till 1985.[1] Poly Ether Ether Ketone, better know as PEEK, entered the market in 1978[2] and General Electric introduced Polyether Imide (PEI), also know as Ultem, in 1982[3].

Along the way, thousands and thousands of other resins have been developed and brought to market. According to IDES, a plastic materials information management company, they have access to more than 80,000 datasheets from 773 different worldwide resin suppliers.[4] The number of choices it can seem to be overwhelming.

Within the vast number of options, there are grades for various types of processing options. Thermosets, thermoplastics, and elastomers, are just some of the family of choices. Within these, there are moldable grades, extrudable grades, highly-filled grades and even very industry specific options such as implantable grades. The focus however of this review is not to try and tackle every known option but to narrow the topic to a couple of basic ideas as it relates to micro-injection molding. Our goal is to provide a brief overview of some of the more popular materials we are asked to mold every day and present a comparative study of these materials in the micro-mold environment as it relates to features, specifically thin-wall applications.

Material Review

Today's design engineers and mechanical designers are often asked to wear many hats in their organizations. Often they are expected to carry the expertise of many different disciplines. You might be classically trained to understand mechanical structures but only a novice when it comes to the chemical or bio properties of resin beyond a class or two. Somehow you're expected to take what you know, match it with what your company needs and find a way to make it happen anyway.

Several questions are helpful as the resin selection process begins. Some questions include: What environmental conditions will the part need to operate under? Does it need to withstand solder reflow temperatures or other high-heat situations? Does it touch the human body or other bio-materials? Are there lubricity or hygroscopic properties to include or exclude? These are just some of the good questions to be asked. Through this review of you will hopefully gain some insight as a starting point for your next project.

1. Polyethylene (HDPE)

Polyethylene, first accidentally developed in 1898 by Hans von Pechmann[5], is considered the most “widely used” of the plastic resins available. It is estimated that 80 million metric tons of material are used annually.[6] It’s most common use is for packaging, specifically plastic bags.[7]

It wasn’t until the 1930s when it began production for commercial use when English scientists “accidentally” developed a standardized process for the basis. The initial synthesis, low-density polyethylene (LDPE), began production in 1939. Its common counterpart, high-density polyethylene (HDPE), another accidental discovery by scientists at Phillips Petroleum, began in 1953.[8]

Both LDPE and HDPE are widely used in the packaging or containment industries. LDPE often finds itself in the form of film as the basis of plastic bags or coatings over paper for items like milk cartons. Other common uses include blow-molded containers for a variety of markets including medical and cosmetics. The injection-molded applications are also found in common household products like mop buckets or other kitchen containers. HDPE is more common for injection-molded applications. While it can be processed as a film or extrusion, molded HDPE for bottles, shipping containers and other distribution or storage devices is widely used.

2. Polypropylene (PP)

Polypropylene was first developed in the mid-1950s by scientists Paul Hogan and Robert L. Banks (the same two from Phillips Petroleum that discovered the HDPE). They were working with ethylene and propylene separately for a project and “accidentally” combined the two materials forming both crystalline polypropylene and linear polyethylene.[9]

Polypropylene is considered a very durable and inexpensive material. It has a high tensile strength and can withstand high amounts of compression. It is also considered very resistant to many solvents, chemicals, and acids. Polypropylene has a large variety of industrial uses because of these properties. It is also widely used in the medical industry because of its chemical resistance and non-toxicity properties as well.[10]

“PP is normally tough and flexible, especially when copolymerized with ethylene; this allows polypropylene to be used as an engineering plastic, competing with materials such as ABS.[11]”





3. Nylon (Polyamide)

Nylon, or polyamide, is a highly engineered thermoplastic synthesized from ethylenediamine.[12] The material was first introduced in 1938 by DuPont as a fiber and then as an injection moldable grade in 1941.[13]

The most common variation of Nylon in the U.S. is Nylon 6/6, others like Nylon 6 and 12 are also very common. This family of resins is noted for excellent “weather and friction-resistant” properties. Common applications include gears, bearings, and mountings. It is also common to find the material blended with an additive such as glass for reinforcement.[14] Moisture absorption can be an issue in some applications because of its hygroscopic nature.[15]



4. Polycarbonate (PC)

Polycarbonate was first sold commercially in 1958 when both Bayer and GE scientists from across the globe independently “discovered” similar processes for producing the material earlier that decade. GE’s material, Lexan, and Bayer’s Makrolon are still common brands of PC today.[16]

Online plastics and elastomers portal, Omnexus.com, aptly describes polycarbonate. “Polycarbonate is a transparent amorphous polymer which exhibits outstanding physical properties such as outstanding impact resistance (almost unbreakable), heat resistance up to 125°C and excellent clarity, although opaque and translucent grades are also available. Polycarbonate is often used to replace glass or metal in demanding applications when the temperature does not exceed 125°C.” [17]



5. Delrin (Acetal / Polyoxymethylene / POM)

Polyoxymethylene, or Acetal, or its more common trade name, Delrin, was first developed in the 1920s but because it was not considered thermally stable, it wasn’t initially commercialized. It wasn’t until 1952 when DuPont scientist stabilized the process, a patent was filed in 1956, and commercial production began in 1960.[18] Today you can find a variety of other versions of the POM-based material from other vendors as well.

Acetal plastics are known to be fairly chemically resistant and are very hydrophobic in nature. However, it is not considered to have high strength resistance and has a “very high” coefficient of thermal expansion. It’s considered to have a low melt temperature as well. This, along with its resistance to water, has made it an ideal choice for applications where wear is an issue such as bearings, wheels, casters, etc. It also has common use within the food industry.[19]

6. Polysulfone (PSU)

Polysulfone, known for its “toughness and stability at high temps,” was first introduced to the market in 1965 by Union Carbide. It is considered the “highest service temperature of all melt-processable thermoplastics.” It’s also used as a high-end replacement to Polycarbonate for specialty applications.[20]

Because of its heat resistance, it has taken on a role as a flame retardant for some applications. It is also a good candidate for some medical devices because it can withstand some of the re-sterilization processes demanded by that industry.[21] Some variations of Polysulfone can have a heat-deflection rating of 345°F (174°C).[22]

Polysulfone is considered a high-cost engineered resin. Along with the previously mentioned attributes it also has advantages for transparency, low moisture absorption, and chemical/solvent resistance.[23]

7. Polybutylene terephthalate (PBT)

Polybutylene Terephthalate was first marketed in 1970 by the company now known as Ticona.[24] PBT is a semi-crystalline resin with “excellent” mechanical and electrical properties. It is also considered highly resistant to chemicals.[25] The material tends to shrink very little during forming and is mechanically very strong.

Other properties characteristic of this material are high heat resistance, low moisture absorption and it makes a great insulator in electronic applications. This material also has a flame-retardant grade that is also commonly used. Other PBT applications include automotive, industrial, consumer goods and medical.[26]

8. Acrylic (Polymethyl methacrylate / PMMA)

Acrylic, developed in the 1930’s as a coating, commercialized in 1937 as a moldable resin. Although it comes in many other variations, it is probably best known by the name of Plexiglas and has played an important role in safety and glass replacements.[27] Its extremely high durability and transparency make it a perfect candidate for extended life applications.

Acrylic is also commonly used where light transmission is a necessary trait such as in taillights, display screens or windows.[28] Plastics web portal IDES.com adds: “Acrylics are widely used in lighting fixtures because they are slow-burning or even self-extinguishing, and they do not produce harmful smoke or gases in the presence of flame.”[29]



9. PEEK (Polyether ether ketone)

British chemical company, Imperial Chemical Industries (ICI), first patented the PEEK formulation in 1978 under the trade name Vitrex.[30] The PEEK polymerization is considered an “organic polymer thermoplastic” and is resistant to thermal breakdown and is mechanically and chemically very stable.[31]

PEEK is also considered an “advanced biomaterial” and is sought after in the medical device manufacturing world, especially implantables. Outside of medical uses, properties of PEEK also make it an option for other demanding applications such as aerospace, automotive and chemical diagnostic industries.[32]



10. Ultem (Polyetherimide / PEI)

Polyetherimide, otherwise known by its trade name Ultem, was introduced by General Electric (now SABIC) in 1982.[33] PEI is considered to be a relative to PEEK. It's typically cheaper than PEEK, it's also clear (or amber) but is less resistant to heat and strength when compared to its cousin. It can withstand continuous use temperatures of 340°F (170°C).[34]

Typical applications for Ultem are Medical, Automotive, Electronics and Aerospace.[35] While not necessarily considered an optical grade material Ultem is also highly used in the telecommunications market for fiber optic connectors. Its clarity is within the light transmission ranges for the fiber products and the natural heat deflection, and low coefficient of thermal expansion makes it an optimal resin for these tight tolerance applications.[36]

Manufacture, SABIC, says: “The Ultem Resin family of amorphous thermoplastic polyetherimide (PEI) resins offers outstanding elevated thermal resistance, high strength and stiffness, and broad chemical resistance. Ultem is available in transparent and opaque custom colors, as well as glass filled grades. Plus, Ultem copolymers are available for even higher heat, chemical and elasticity needs. Ultem resins uniquely balance both mechanical properties and processability, offering design engineers exceptional flexibility and freedom.”[37]



11. LCP (Liquid Crystal Polymer)

LCP, or Liquid Crystal Polymer, as a moldable resin is relatively new even though the components and research that ultimately lead to the resin we know today happened as early as 1888.[38] It wasn't till 1980, almost 100 years later, that the injection moldable version was available to the market.[39]

LCP is in a unique class of highly-engineered thermoplastic because of its base formulation that's capable of forming "regions of highly ordered structure." [40] The material is considered very strong but expensive as a resin. It has good heat-deflection properties and can handle most solder reflow processes. It's also a great candidate for thin-wall applications.[41]

Plastics compounder and supplier RTP says this about LCP: "LCP can replace such materials as ceramics, metals, composites and other plastics because of its outstanding strength at extreme temperatures and resistance to virtually all chemicals, weathering, radiation and burning." [42]

Other Variables:

It's important to understand that there are a lot of other variables that can affect the performance of a molded part. Most of the available thermoplastics have different grades or versions that are produced to achieve different kinds of results. Additives such as glass, carbon, or other fibers are a common practice when looking to add properties to the resin. All of these situations can affect how the material melts, flows and fills any given geometry.

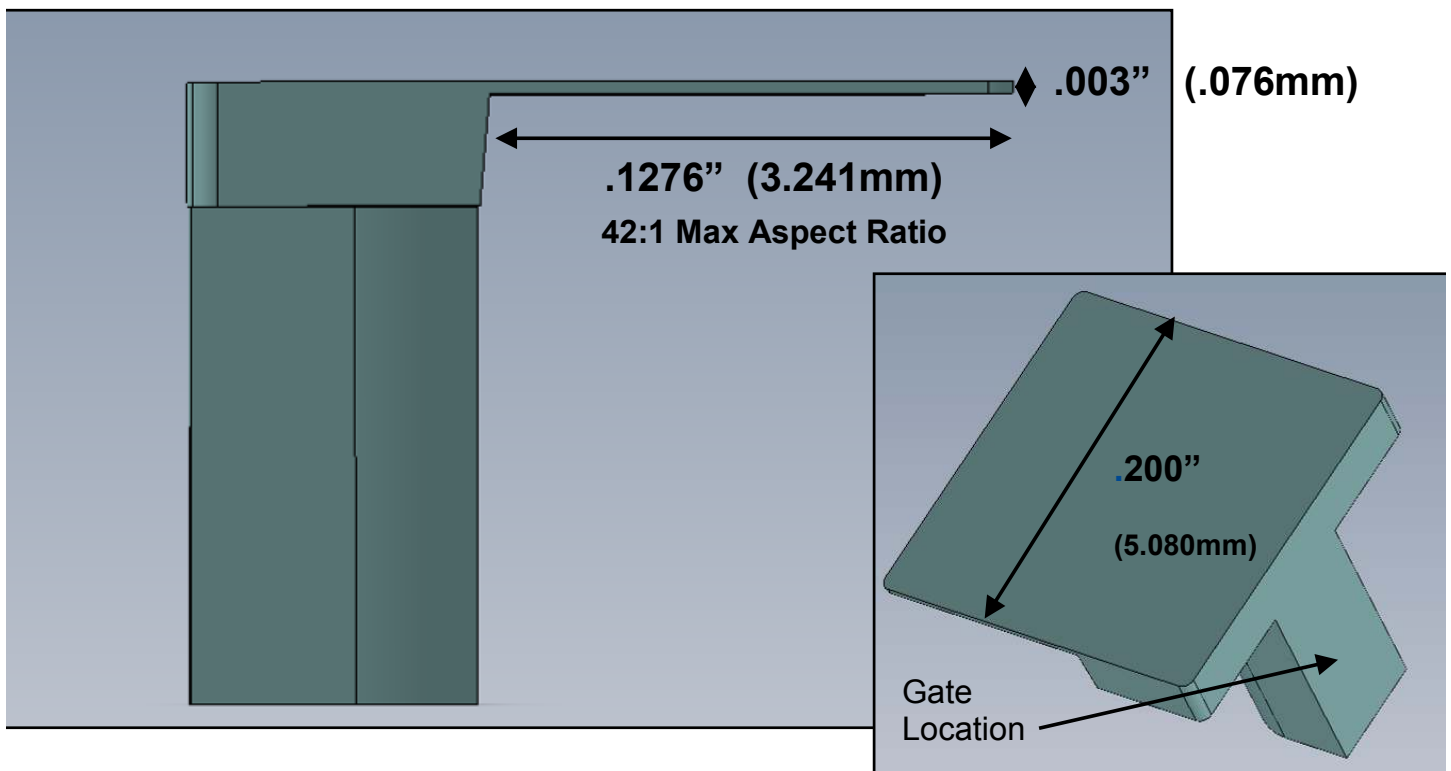

Study Design

The purpose of this study is to compare some common engineered resins to their performance in a thin-wall application. The goal was to see how far we could push the different resins and take note of how they compared. The mold was not modified for each resin, including the gate or runner system. We used the standard processing windows as specified for each resin as the only variable to give each process a chance to fill the part on its own. The only critical dimension observed was to keep the .003" thickness.

Our results show how resin selection affects the desired output when designing a part.

It's also important to note that this is also one situation. The mold was built with a thick to thin transition to create an optimal opportunity for the parts to fill. This is not always possible when designing your parts since the variables of where and how it needs to function are as wide as they are deep. However, knowing what resins might give the best possible chance for success can be very helpful when matching the properties and features to your project.

As we prepared this study, we evaluated a tool used to determine cavity resin fill called Moldflow. Moldflow takes the data from the resin properties and tries to estimate the flow through your design. This can be very helpful to know where knit lines or end-of-fill might be. It can also discover clues in determining if your chosen material will have the desired outcome.

Our desire was to compare our results with a Moldflow study but unfortunately, we were not successful finding anyone willing to run our processes. In fact, we were informed the analysis would either fail to estimate correctly or that the part itself was simply not moldable. Our own anecdotal experience confirmed this reaction but we were hopeful to at least show some data.

We knew from previous experience, many of the parts we've made for decades are considered to be impossible to mold according to the common flow analysis.

We also asked our resin suppliers for their opinion on the moldability of this part and what material might give it the best chance to fill. In all cases, their opinions communicated doubt the part was moldable and most suggested we make the part thicker. This is a common response we receive. It's also important to note that even looking at the resin data sheets can lead to inconclusive expectations when applied to the micro-mold area. These data sheets are often calculated using much larger sample bars and their stated parameters may not apply. For example, most recommended gate sizes are larger than many of the micro-molded parts we produce. Some sheets even refer to "easy flow" or "high flow" grades however they are probably not referring to a .003" thin section with this description. It's typically recommended that you consult with your micro-molder when in doubt.

Study Results

Below you will see how each of the resins compared in our study. We made 100 parts of each and measured a sample from each lot to examine the data. Remember: This isn't a study to see how far we could push each material. The critical concern was to keep the .003" height more than the length of fill. Simply increasing the pressures and blowing open the mold would not have given us the right data. The mold was not adjusted either for performance or shrink. In some cases we could probably get the materials to perform better had we modified the mold specifically for that material. We wanted to show in as much of a controlled environment as we could how resin selection reacts to one design.

Executive Summary

This study tackles one of the most widely asked questions of Accumold, resin selection assistance. This study shows how, in terms of micro-molding, picking resins based on data sheets can be misleading or confusing. It's important to consult with your molder when designing parts that may be considered outside the norm.

When you're talking about small parts or features it's obvious to see how much variance there can be with material choice alone. Understanding the full environment the part must perform in is crucial. Mechanical strength, chemical resistance, cost and the ability to fill the part design are all important factors. Balancing part function and material function can be more challenging in this arena than one might expect.

Data & Comparisons

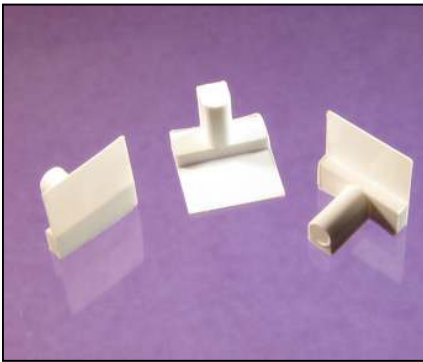

PE - HDPE Fortiflex T50-2000 + white

Notable Vendor Comments *[43]

“Glossy surface finish and reasonably good impact strength and rigidity”
“It is characterized by a high melt index which allows easy processing of medium to thin-walled articles.”

Melt Flow: 20.0g/10 min @ Load 4.76 lb, Temperature 374 °F

Tensile Strength, Yield: 3900 psi

Flexural Modulus: 185.1 ksi

Deflection Temperature: 169°F (at 0.46 MPa (66 psi))

Our Results: (Average Sampled)

Length: 0.1257”

Aspect Ratio: 42:1

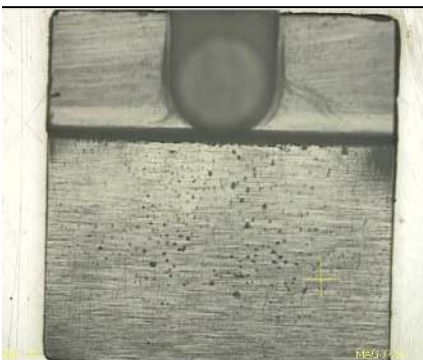

Conclusion:

Allowing for material shrink this filled to completion and could probably push further. It is a very flexible material at this thickness, which may or may not be desirable.

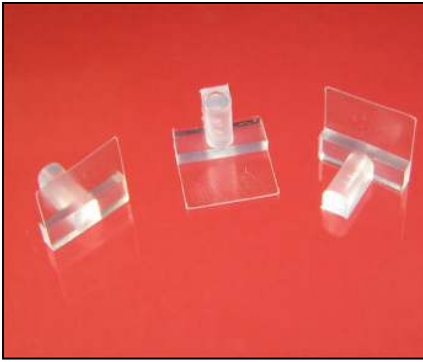

PP - BasellPro-Fax PF511

Notable Vendor Comments *[44]

“radiation-resistant polypropylene homopolymer resin”

“excellent retention of physical properties and color after radiation sterilization”

Melt Flow: 20.0g/10 min @ Load 4.76 lb, Temperature 446°F

Tensile Strength, Yield: 3920 psi

Flexural Modulus: 113 ksi

Deflection Temperature: 169°F (at 0.46 MPa / 66 psi)

Our Results: (Average Sampled)

Length: 0.1237”

Aspect Ratio: 42:1

Conclusion:

The PP showed it is capable of filling completely, probably with a few adjustments. This experiment showed a few short shots where the material didn't flow as easy as others under the same constraints.

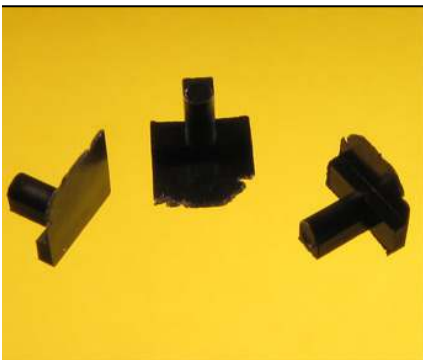
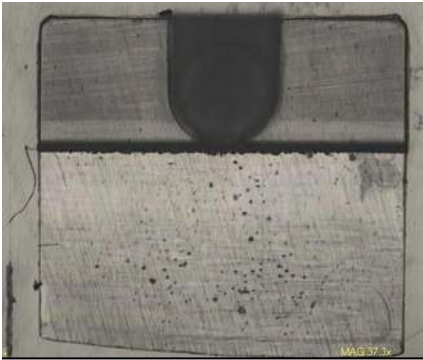

NYLON - 6/6 50% GF BLACK

Notable Vendor Comments * [45]

“50% Glass Fiber Reinforced”

“Black Colorant”

Melt Flow: N/A

Tensile Strength, Break: 30000 psi

Flexural Modulus: 2100 ksi

Deflection Temperature: 480°F (at 1.8 MPa / 264 psi)

Our Results: (Average Sampled)

Length: 0.0529”

Aspect Ratio: 18:1

Conclusion:

In an ideal situation you might be able to push beyond the average aspect or in situations where the width was not so wide. While it seemed the part would push well beyond average when measuring fill at the full 0.2” width it came quite short due to uneven fill.



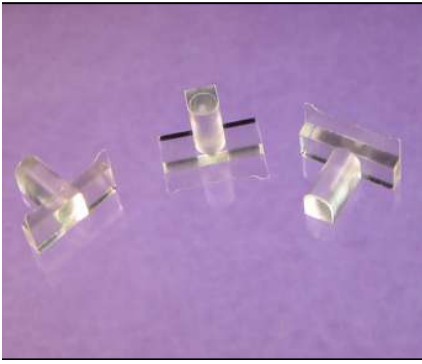

PC - LEXAN HPXS8R-1H9D044T

Notable Vendor Comments *[46]

“Very high flow specialty polycarbonate with outstanding processability and ductility.”

“For medical devices and pharmaceutical applications”

Melt Flow: 33.0g/10 min @ Load 2.65 lb, Temperature 572 °F

Tensile Strength, Yield: 8560 psi

Flexural Modulus: 185.1 ksi

Deflection Temperature: 243°F (at 1.8 MPa / 264 psi)

Our Results: (Average Sampled)

Length: 0.0411”

Aspect Ratio: 14:1

Conclusion:

The PC had a consistent fill pattern. Under normal processing parameters it didn't push very far.

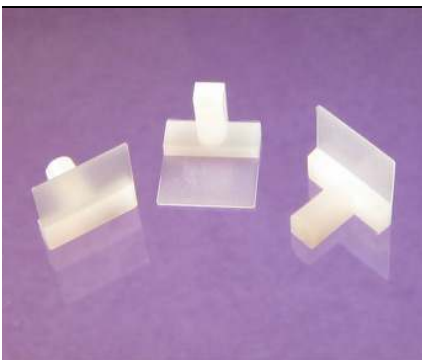
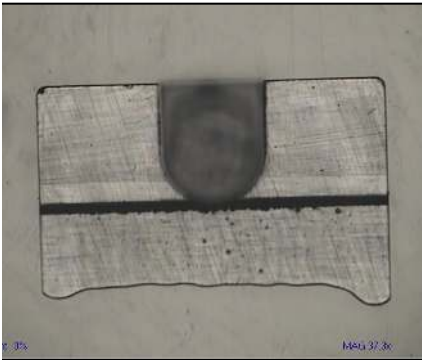

POM - DELRIN 900P NC010

Notable Vendor Comments *[47]

“Low viscosity acetal homopolymer resin for multicavity and thin wall molding”

“It offers an improved processing thermal stability.”

Melt Flow: 11.0g/10 min @ Load 2.31 lb, Temperature 374 °F

Tensile Strength, Yield: 4350-14100 psi (based on temp)

Flexural Modulus: 120-580 ksi (based on temp)

Deflection Temperature: 324°F (at 0.46 MPa / 66 psi)

Our Results: (Average Sampled)

Length: 0.1242”

Aspect Ratio: 42:1

Conclusion:

The Delrin filled fully as seen by the finished end. Since the mold was not adjusted for material shrink this was to be expected. It also followed suit with the vendor's comments.



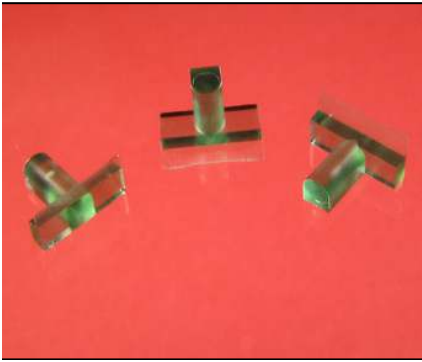

PSU - UDEL P1700

Notable Vendor Comments *[48]

“A tough, rigid, high-strength amorphous thermoplastic that maintains its properties over a wide temperature range.”

“Good electrical properties, clarity and toughness, plus exceptional steam resistance.”

Melt Flow: 6.5g/10min

Tensile Strength, Yield: 10000 psi

Flexural Modulus: 390 ksi

Deflection Temperature: 345°F at 1.8 MPa (264 psi)

Our Results: (Average Sampled)

Length: 0.0418”

Aspect Ratio: 14:1

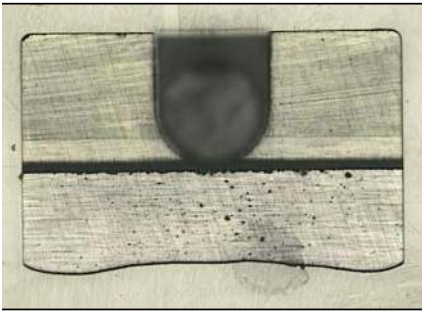

Conclusion:

Not necessarily an ideal candidate for long aspect thin molding, though 14:1 is not a bad aspect. The material is also very flexible at this thickness.

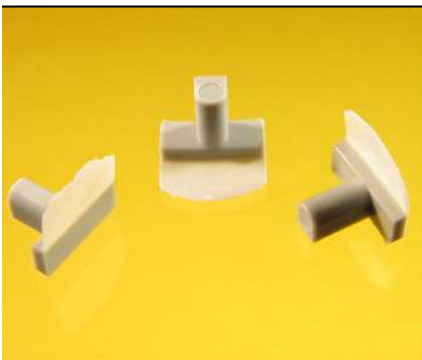

PBT - VALOX 420SE0 GRAY 8051

Notable Vendor Comments *[49]

“30% GR, UL94V-0/5V rated”

“Numerous applications; edge trimmers, food mixer motor stator and commutator, cooling fan, connectors, bobbins, switches etc.”

Melt Flow: 29.0g/10 min @ Load 11 lb, Temperature 482 °F

Tensile Strength, Yield: 16500 psi

Flexural Modulus: 1380 ksi

Deflection Temperature: 383°F (at 0.46 MPa / 66 psi)

Our Results: (Average Sampled)

Length: 0.0753”

Aspect Ratio: 25:1

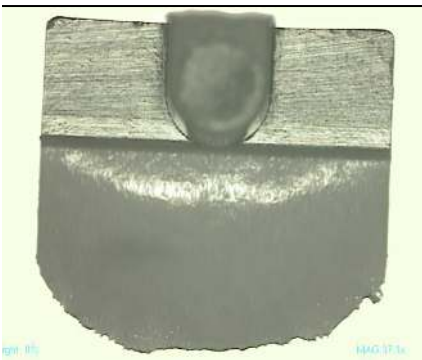

Conclusion:

The Valox did a decent job filling the part. The center tended to push further. The part also showed signs of severe warpage at this thickness.

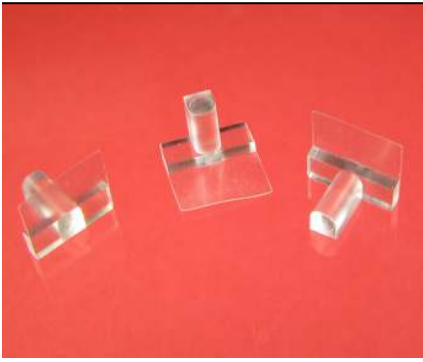

PMMA - ACR Cyrolite GS-90 Multipolymer

Notable Vendor Comments *[50]

“Uses: medical devices, molded applications; excellent gamma resistance”

Melt Flow: 6.5 g/10 min @ Load 11.0 lb, Temperature 446 °F

Tensile Strength, Break: 6300 psi

Flexural Modulus: 330 ksi

Deflection Temperature: 63°F (at 1.8 MPa / 264 psi)

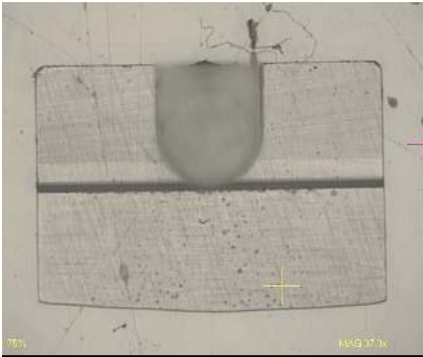

Our Results: (Average Sampled)

Length: 0.0776”

Aspect Ratio: 26:1

Conclusion:

In an ideal situation you might be able to push beyond our averaged aspect or in situations where the width was not so wide. Our furthest push with this material in this study got to a 32:1 ratio. Warpage was an issue.



PEEK - 150 GL30 NATURAL

Notable Vendor Comments *[51]

“Easy flow, 30% glass fiber reinforced, pelletized grade for injection molding.”

Melt Flow: 16.0g/10 min @ Load 11.0 lb, Temperature 752 °F

Tensile Strength, Ultimate: 25800 psi

Flexural Modulus: 1410 ksi

Deflection Temperature: 599°F (at 1.8 MPa / 264 psi)

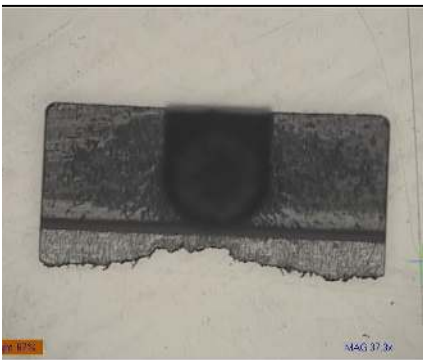

Our Results: (Average Sampled)

Length: 0.0090”

Aspect Ratio: 3:1

Conclusion:

This PEEK barely made it out and averaged a very short 3:1 aspect. Center of fill was the shortest. Maybe with a narrower selection it could push a bit further. The is also considered “easy flow” material by the vendor’s description.

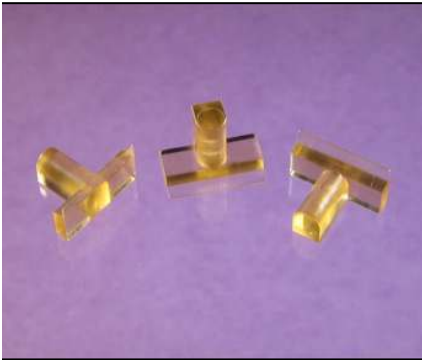

PEI - ULTEM 1010-1000 NATURAL

Notable Vendor Comments *[52]

“Transparent, enhanced flow”

Melt Flow: 17.8 g/10 min @ Load 14.6 lb, Temperature 639 °F

Tensile Strength, Yield: 16000 psi

Flexural Modulus: 509 ksi

Deflection Temperature: 405°F (at 0.46 MPa / 66 psi)

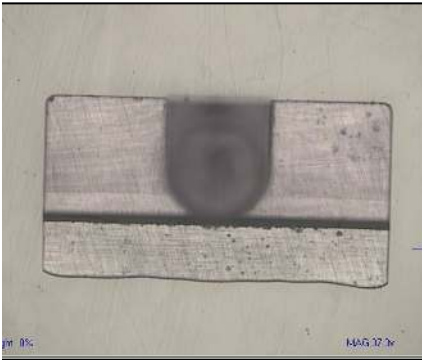

Our Results: (Average Sampled)

Length: 0.0294”

Aspect Ratio: 10:1

Conclusion:

An extremely even fill even though it didn't make it that far. This was also considered an “enhanced flow” material.



LCP - VECTRA E130I BLK

Notable Vendor Comments *[53]

“30% Glass Fiber Reinforced”

“Black”

Melt Flow: N/A. Latent Heat of Fusion to close to melt

Tensile Strength, Ultimate: 23200 psi

Flexural Modulus: 2320 ksi

Deflection Temperature: 536°F (at 1.8 MPa / 264 psi)



Our Results: (Average Sampled)

Length: 0.1265”

Aspect Ratio: 42:1

Conclusion:

The part filled completely. Again, given the shrink factor this would most certainly meet the max 0.1276” length and probably further.

Results Overview

Base Material:	LCP	PP	HDPE	POM	PMMA	PBT	NYLON	PSU	PC	PEI	PEEK
	VECTRA E130I BLK	BasellPro-Fax PF511	HDPE Fortiflex TPE 2000 + whi	DELTRIN 900P NC010	Cyrolite GS-Multipolymer	VALOX 420SE0 GRT 8051	NYLON - 6/6 50% BLACK	UDEL P1700	LEXAN HPXS8G 1H9D044	ULTEM 1010-10I NATURA	150 GL30 NATURAL
Resin:											
Average Aspect Ratio:	42:1	42:1	42:1	42:1	26:1	25:1	18:1	14:1	14:1	10:1	3:1
Max Measurement:	0.1269"	0.1268"	0.1261"	0.1244"	0.0962"	0.0828"	0.0611"	0.0483"	0.0421"	0.0379"	0.0125"
<u>Material Properties</u>											
Melt Flow:	N/A	20g	20g	11g	6.5g	29g	N/A	6.5g	33g	17.8g	16g
Tensile Strength:	23200 psi	3920 psi	3900 psi	4350-14100 psi	6300 psi	16500 psi	30000 psi	10000 psi	8560 psi	16000 psi	25800 psi
Flexural Modulus:	2320 ksi	113 ksi	185.1 ksi	120-580 ksi	330 ksi	1380 ksi	2100 ksi	390 ksi	185.1 ksi	509 ksi	1410 ksi
Deflection Temperature:	536°F	169°F	169°F	324°F	163°F	383°F	480°F	345°F	243°F	405°F	599°F

Polvethvlene (PE)



Polvproovlene (PP)

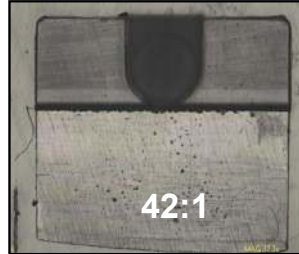

Polvamide (Nylon)

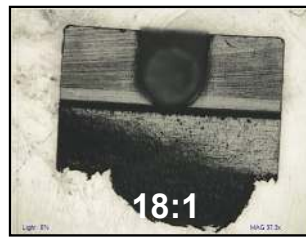

Polvcarbonate (PC)

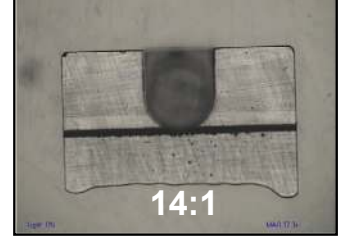

Polvsulfone (PSU)

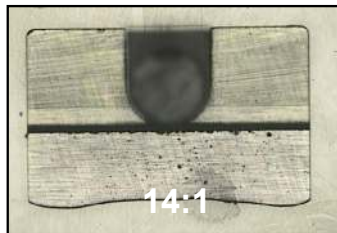

Polvooxvmethvlene (POM)

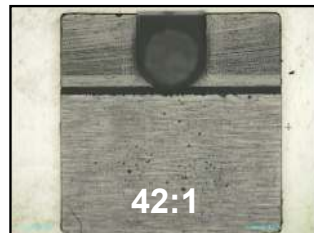

Polybutylene Terephthalate (PBT)

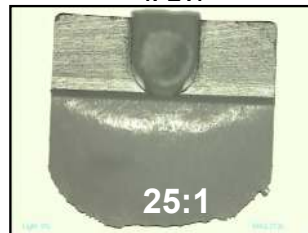

Polymethyl Methacrylate (PMMA)

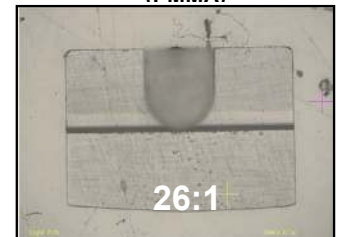

Polyether Ether Ketone (PEEK)



Polvetherimide (PEI)

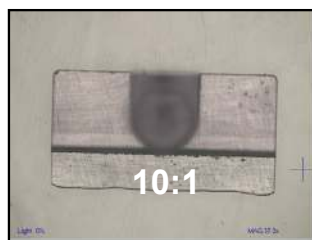

Liquid Crvstal Polvmer



REFERENCES

- [1] <http://inventors.about.com/od/pstartinventions/a/plastics.htm>
- [2] <http://www.victrexpeeturns30.com/en/PEEK-30-anniversary.php?>
- [3] http://www.ides.com/generics/PEI/PEI_overview.htm
- [4] <http://www.ides.com/about/overview.asp>
- [5] <http://en.wikipedia.org/wiki/Polyethylene#CITEREFPringerBaner2008>
- [6] <http://books.google.com/books?id=UoFgsNEHbAC&pg=PA32>
- [7] <http://en.wikipedia.org/wiki/Polyethylene#CITEREFPringerBaner2008>
- [8] <http://en.wikipedia.org/wiki/Polyethylene#CITEREFPringerBaner2008>
- [9] <http://books.google.com/books?id=GjtJfmxvSWgC&pg=PA76>
- [10] <http://www.lenntech.com/polypropylene.htm>
- [11] <http://en.wikipedia.org/wiki/Polypropylene>
- [12] <http://www.wisegeek.com/what-is-nylon-resin.htm>
- [13] <http://www.alliancepoly.com/nylon.asp>
- [14] <http://www.wisegeek.com/what-is-nylon-resin.htm>
- [15] <http://www.alliancepoly.com/nylon.asp>
- [16] http://news.thomasnet.com/IMT/archives/2003/09/polycarbonate_5.html
- [17] <http://www.omnexus.com/tc/polycarbonate/index.aspx>
- [18] http://en.wikipedia.org/wiki/Polyoxymethylene_plastic
- [19] http://en.wikipedia.org/wiki/Polyoxymethylene_plastic
- [20] <http://en.wikipedia.org/wiki/Polysulfone>
- [21] <http://en.wikipedia.org/wiki/Polysulfone>
- [22] <http://www.solvayadvancedpolymers.com/products/bybrand/udel/0,,330-2-0,00.htm>
- [23] <http://www.ides.com/generics/PSU.htm>
- [24] <http://www.polyplastics.com/en/product/lines/pbt/his.html>
- [25] <http://www.omnexus.com/tc/PBT/index.aspx>
- [26] <http://www.omnexus.com/tc/PBT/index.aspx>
- [27] <http://www.ridoutplastics.com/briefhisofpl.html>
- [28] http://en.wikipedia.org/wiki/Acrylic_resin
- [29] <http://www.ides.com/generics/Acrylic.htm>
- [30] http://en.wikipedia.org/wiki/Imperial_Chemical_Industries
- [31] <http://en.wikipedia.org/wiki/PEEK>
- [32] <http://en.wikipedia.org/wiki/PEEK>
- [33] http://www.ides.com/generics/PEI/PEI_overview.htm
- [34] <http://en.wikipedia.org/wiki/Polyetherimide>
- [35] http://www.ides.com/generics/PEI/PEI_overview.htm
- [36] <http://www.hycompinc.com/PDFs/ULTEMPProductBrochure.pdf>
- [37] <http://www.sabic-ip.com/gep/Plastics/en/ProductsAndServices/ProductLine/ultem.html>
- [38] http://en.wikipedia.org/wiki/Liquid_crystal
- [39] http://www.efunda.com/materials/polymers/history/history.cfm?list_order=time
- [40] http://en.wikipedia.org/wiki/Liquid_crystal_polymer
- [41] http://www.efunda.com/materials/polymers/properties/polymer_cat.cfm?MajorID=LCP
- [42] <http://www.rtpcompany.com/info/guide/descriptions/3400.htm>
- [43] <http://www.matweb.com/search/DataSheet.aspx?MatGUID=1731dcd91f4d4eadbaa0c2fbd620efc&ckck=1>
- [44] http://www.matweb.com/search/datasheet_print.aspx?matguid=c20ada56a95a431f92d8f16b8df2fcc
- [45] <http://www.rtpcompany.com/info/data/0200/RTP209.htm>
- [46] <http://www.matweb.com/search/DataSheet.aspx?MatGUID=0111191ffb294339abe26ac1472b30f3>
- [47] http://www.matweb.com/search/datasheet_print.aspx?matguid=d1f38e51d0a542819a0691cc863647e3
- [48] http://www.matweb.com/search/datasheet_print.aspx?matguid=edf317ef63674355844f51a275db9889
- [49] http://www.matweb.com/search/datasheet_print.aspx?matguid=e09a88c93ba04337a49a5f6d5f5c1502
- [50] http://www.matweb.com/search/datasheet_print.aspx?matguid=c3e8e1d14f7e43d997620d2c6edda77d
- [51] http://www.matweb.com/search/datasheet_print.aspx?matguid=e4dfb11fe7564070982572be457df61e
- [52] http://www.matweb.com/search/datasheet_print.aspx?matguid=9588336ba7bd47e0992f866a5e06ffe1
- [53] <http://www.matweb.com/search/DataSheet.aspx?MatGUID=1731dcd91f4d4eadbaa0c2fbd620efc&ckck=1>